

Route de Bassins 9
Le Vaud
Tel +41 22 366 46 07
furrer.sarl@bluewin.ch
www.croisillon.ch
CHE-110.221.023 TVA

croisillon.ch

FURRER
Thermoplast Sarl



INFORMATIONS :

SET A EMBOITER

Le croisillon « SET A EMBOITER » est composé de deux pièces emboîtables faciles à monter. Très pratique pour le stockage, prend peu de place. Il peut être posé monté (set), ou posé seul dans le cas de joints croisés.

Son prix HT indiqué est pour un set (soit 2 unités emboîtables formant une croix)

PP (Polypropylène recyclé)

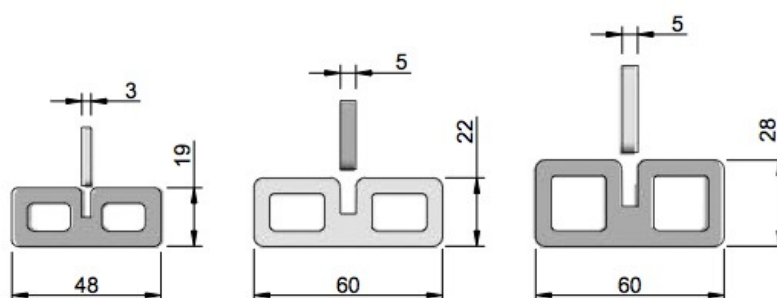

BREAK IT

Le croisillon « BREAK IT » est un croisillon d'une pièce avec une entaille pour faciliter la casse d'une branche.

Apprécié pour la pose en joints croisés et pour les dalles de bordure. D'une hauteur de 13 mm pour la pose de dalle à épaisseur réduite

PP (Polypropylène recyclé)

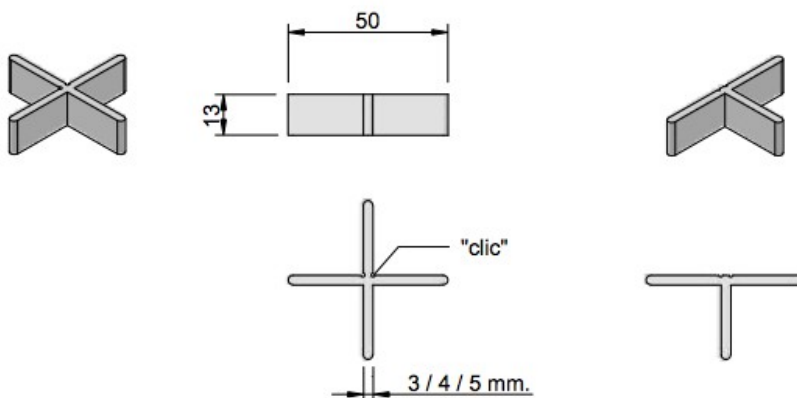



PLATE

Le croisillon « **PLATE** » est un croisillon d'une pièce posé sur un disque pour éviter que le croisillon ne remonte.

Le « **T** » est apprécié pour la pose en joints croisés et pour les dalles de bordure. D'une hauteur de 13 mm pour la pose de dalle à épaisseur réduite

PP (Polypropylène recyclé)

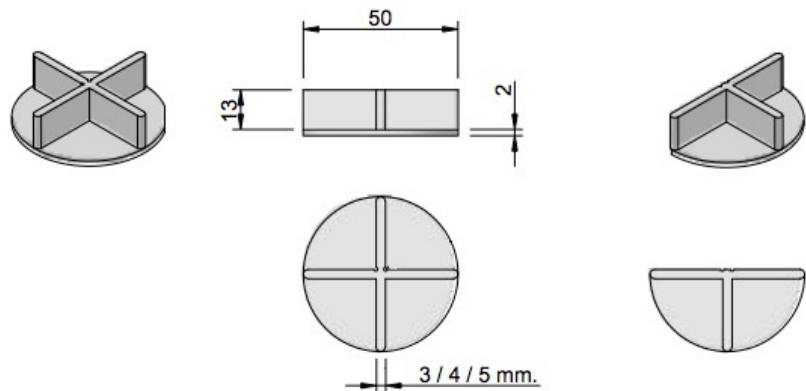

STOP LIFT

Le croisillon « **STOP LIFT** » est un croisillon d'une pièce avec un aplat, ce qui évite que le croisillon ne remonte.

Un croisillon de très bon rapport qualité prix.

Le « **T** » est apprécié pour la pose en joints croisés et pour les dalles de bordure. D'une hauteur de 13 mm pour la pose de dalle à épaisseur réduite

PP (Polypropylène recyclé)

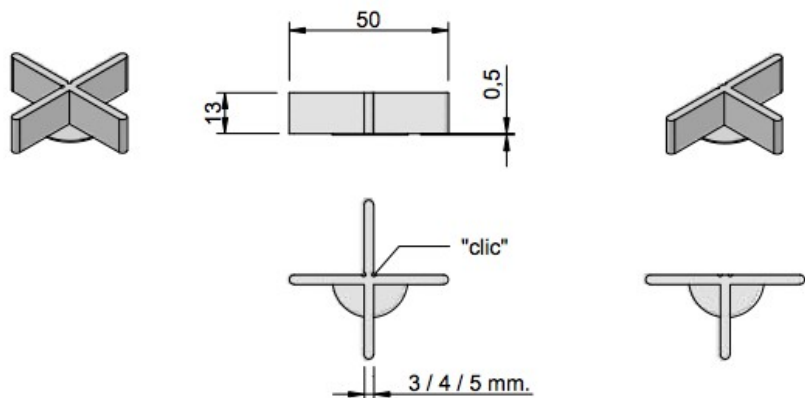



STOP LIFT 2

Le croisillon «**STOP LIFT 2**» est un croisillon d'une pièce avec un aplat, ce qui évite que le croisillon ne remonte.

Un croisillon de très bon rapport qualité prix, qui remplace le « **PLATE** »

PP (Polypropylène recyclé)

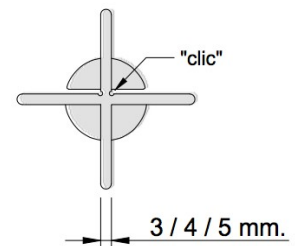
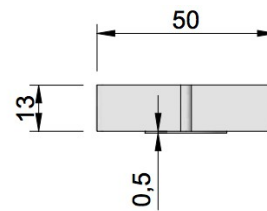
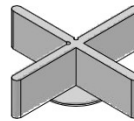

COMMANDE / LIVRAISON / PAIEMENT

Prix : Les prix indiqués sont hors taxe TVA 7.7%

Commande : Par notre site internet, www.croisillon.ch ou par mail furrer.sarl@bluewin.ch

Livraison : Poste 2 – 4 j. ouvrable, gratuite pour toute la Suisse

Condition de paiement : Facture 30 jours net.

En cas de rappel: Les frais de relances se déroulent comme suit :

Rappel n°1
Rappel n°2 : 25.00.-
Rappel n°3 : 50.00.-
Rappel n°4 : Poursuites

CONDITIONNEMENT (emballage)

Emballage de 300 / 1000 pc avec ouverture easy rip



Route de Bassins 9
 Le Vaud
 Tel +41 22 366 46 07
furrer.sarl@bluewin.ch
www.croisillon.ch
 CHE-110.221.023 TVA

croisillon.ch

FURRER
 Thermoplast Sarl



LISTE DE PRIX 2021 EN CHF HT.

Quantité	Art.	Larg.	Type	L, l, H	CHF./pc	Total HT
----------	------	-------	------	---------	---------	----------

SET A EMBOITER 3 mm. 48 x 48 x 19 mm NOIR/TRANSLUCIDE

	300	A	3 mm		0.32	96.00
	500	A	3 mm		0.21	105.00
	2'500	A	3 mm		0.16	400.00

SET A EMBOITER 5 mm. 60 x 60 x 22 mm NOIR/TRANSLUCIDE

	300	B	5 mm		0.43	129.00
	500	B	5 mm		0.32	160.00
	2'500	B	5 mm		0.21	525.00

PLAQUETTE 3 mm. 110 x 110 x 20 mm 0.00 NOIR/GRIS

	500	C	3 mm.	Plaquette	0.86	428.00
				EPU	0.00	
					0.00	

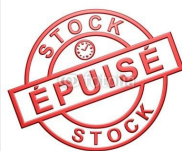







SET A EMBOITER 5 mm. 60 x 60 x 28 mm NOIR/TRANSLUCIDE

	300	D	5 mm		0.59	177.00
	500	D	5 mm		0.48	240.00
	2'500	D	5 mm		0.37	925.00

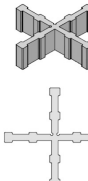

LISTE DE PRIX 2021 EN CHF HT.

Quantité	Art.	Larg.	Type	L, l, H	CHF./pc	Total HT
BREAK IT		3 mm.	50 x 50 x 13 mm		NOIR / TRANSLUCIDE	
	300	E	3 mm		0.27	81.00
	1'000	E	3 mm		0.21	210.00
	2'000	E	3 mm		0.16	320.00
	4'000	E	3 mm		0.13	520.00
BREAK IT		4 mm.	50 x 50 x 13 mm		NOIR / TRANSLUCIDE	
	300	G	4 mm		0.37	111.00
	1'000	G	4 mm		0.27	270.00
	2'000	G	4 mm		0.21	420.00
	4'000	G	4 mm		0.16	640.00
BREAK IT		5 mm.	50 x 50 x 13 mm		NOIR / TRANSLUCIDE	
	300	I	5 mm		0.37	111.00
	1'000	I	5 mm		0.27	270.00
	2'000	I	5 mm		0.21	420.00
	4'000	I	5 mm		0.16	640.00
T		3 mm.	50 x 25 x 13 mm		NOIR / TRANSLUCIDE	
	300	F	3 mm		0.25	75.00
	1'000	F	3 mm		0.19	190.00
	2'000	F	3 mm		0.14	280.00
	4'000	F	3 mm		0.11	440.00
T		4 mm.	50 x 25 x 13 mm		NOIR / TRANSLUCIDE	
	300	H	4 mm		0.35	105.00
	1'000	H	4 mm		0.25	250.00
	2'000	H	4 mm		0.19	380.00
	4'000	H	4 mm		0.14	560.00
T		5 mm.	50 x 25 x 13 mm		NOIR / TRANSLUCIDE	
	300	J	5 mm		0.35	105.00
	1'000	J	5 mm		0.25	250.00
	2'000	J	5 mm		0.19	380.00
	4'000	J	5 mm		0.14	560.00



LISTE DE PRIX 2021 EN CHF HT.

Quantité	Art.	Larg.	Type	L, l, H	CHF./pc	Total HT
----------	------	-------	------	---------	---------	----------

PLATE 3 mm. 50 x 50 x 13 mm NOIR / TRANSLUCIDE

	300	K	3 mm		0.43	129.00
	1'000	K	3 mm		0.37	370.00
	2'000	K	3 mm		0.32	640.00
	4'000	K	3 mm		0.27	1080.00

PLATE 4 mm. 50 x 50 x 13 mm NOIR / TRANSLUCIDE



	300	M	4 mm		0.48	144.00
	1'000	M	4 mm		0.43	430.00
	2'000	M	4 mm		0.37	740.00
	4'000	M	4 mm		0.32	1280.00

PLATE 5 mm. 50 x 50 x 13 mm NOIR / TRANSLUCIDE

	300	O	5 mm		0.54	162.00
	1'000	O	5 mm		0.48	480.00
	2'000	O	5 mm		0.43	860.00
	4'000	O	5 mm		0.37	1480.00

T 3 mm. 50 x 25 x 13 mm NOIR / TRANSLUCIDE

	300	L	3 mm		0.41	123.00
	1'000	L	3 mm		0.35	350.00
	2'000	L	3 mm		0.30	600.00
	4'000	L	3 mm		0.25	1000.00

T 4 mm. 50 x 25 x 13 mm NOIR / TRANSLUCIDE













	300	N	4 mm		0.46	138.00
	1'000	N	4 mm		0.41	410.00
	2'000	N	4 mm		0.35	700.00
	4'000	N	4 mm		0.30	1200.00

T 5 mm. 50 x 25 x 13 mm NOIR / TRANSLUCIDE

	300	P	5 mm		0.51	153.00
	1'000	P	5 mm		0.46	460.00
	2'000	P	5 mm		0.41	820.00
	4'000	P	5 mm		0.35	1400.00



LISTE DE PRIX 2021 EN CHF HT.

Quantité	Art.	Larg.	Type	L, l, H	CHF./pc	Total HT
STOP LIFT		3 mm.	50 x 50 x 13 mm		NOIR / TRANSLUCIDE	
 	300	Q	3 mm		0.32	96.00
	1'000	Q	3 mm		0.25	250.00
	2'000	Q	3 mm		0.18	360.00
	4'000	Q	3 mm		0.15	600.00
STOP LIFT		4 mm.	50 x 50 x 13 mm		NOIR / TRANSLUCIDE	
 	300	S	4 mm		0.43	129.00
	1'000	S	4 mm		0.31	310.00
	2'000	S	4 mm		0.25	500.00
	4'000	S	4 mm		0.18	720.00
STOP LIFT		5 mm.	50 x 50 x 13 mm		NOIR / TRANSLUCIDE	
 	300	U	5 mm		0.43	129.00
	1'000	U	5 mm		0.31	310.00
	2'000	U	5 mm		0.25	500.00
	4'000	U	5 mm		0.18	720.00
T		3 mm.	50 x 25 x 13 mm		NOIR / TRANSLUCIDE	
 	300	R	3 mm		0.30	90.00
	1'000	R	3 mm		0.22	220.00
	2'000	R	3 mm		0.16	320.00
	4'000	R	3 mm		0.13	520.00
T		4 mm.	50 x 25 x 13 mm		NOIR / TRANSLUCIDE	
 	300	T	4 mm		0.41	123.00
	1'000	T	4 mm		0.29	290.00
	2'000	T	4 mm		0.22	440.00
	4'000	T	4 mm		0.16	640.00
T		5 mm.	50 x 25 x 13 mm		NOIR / TRANSLUCIDE	
 	300	V	5 mm		0.41	123.00
	1'000	V	5 mm		0.29	290.00
	2'000	V	5 mm		0.22	440.00
	4'000	V	5 mm		0.16	640.00



LISTE DE PRIX 2021 EN CHF HT.

Quantité	Art.	Larg.	Type	L, l, H	CHF./pc	Total HT
STOP LIFT 2		3 mm.	50 x 50 x 13 mm		NOIR / TRANSLUCIDE	

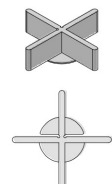

300	W	3 mm	0.37	111.00
1'000	W	3 mm	0.27	270.00
2'000	W	3 mm	0.20	400.00
4'000	W	3 mm	0.16	640.00

STOP LIFT 2		4 mm.	50 x 50 x 13 mm		NOIR / TRANSLUCIDE	
--------------------	--	--------------	------------------------	--	---------------------------	--

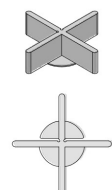

300	X	4 mm	0.45	135.00
1'000	X	4 mm	0.32	320.00
2'000	X	4 mm	0.27	540.00
4'000	X	4 mm	0.21	840.00

STOP LIFT 2		5 mm.	50 x 50 x 13 mm		NOIR / TRANSLUCIDE	
--------------------	--	--------------	------------------------	--	---------------------------	--

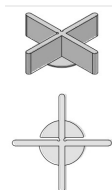

300	Y	5 mm	0.45	135.00
1'000	Y	5 mm	0.32	320.00
2'000	Y	5 mm	0.27	540.00
4'000	Y	5 mm	0.21	840.00

Combien de croisillons pour ma terrasse ?

60x60 = 3 pces/m²

50x50 = 4 pces/m²

40x40 = 6 pces/m²